

# G7A+G7W

COMMERCIAL SMITH MACHINE, POWER RACK AND FUNCTIONAL TRAINER 3 IN 1



## CONDITIONING

Strengthens your heart and lungs while increasing your metabolic rate.



## POWER

Increases speed and agility by activating fast twitch muscle fibers.



## STRENGTH

Increase muscle, tendon and ligament strength; bone density; metabolic rate while improving heart and body composition.



## FLEXIBILITY

Increase range of motion, flexibility and reduce the risk of injury.



## WARNING

Consult your physician before beginning this or any exercise program. Keep out of reach of children.



# G7A+G7W

COMMERCIAL SMITH MACHINE, POWER RACK AND FUNCTIONAL TRAINER 3 IN 1



Different styles

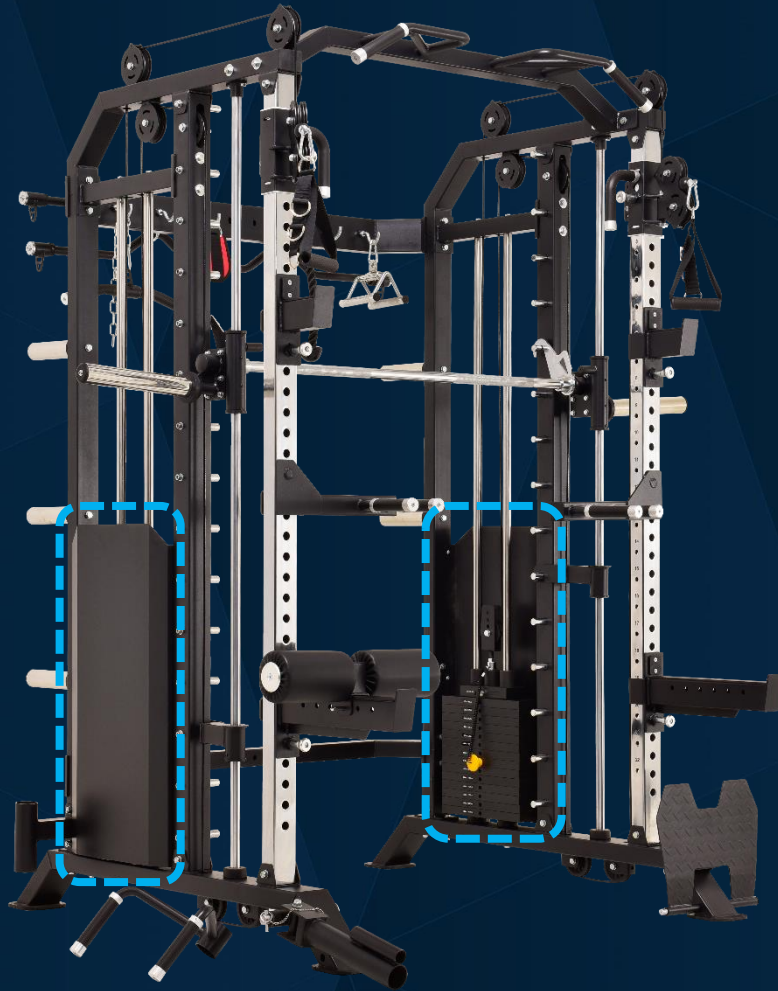

**G7A+G7W**

G7W: Weight stack + Metal cover



**G7A+G7S**

G7S: Weight plate storage



# G7A+G7W

COMMERCIAL SMITH MACHINE, POWER RACK AND FUNCTIONAL TRAINER 3 IN 1



Assembled dimensions (mm)

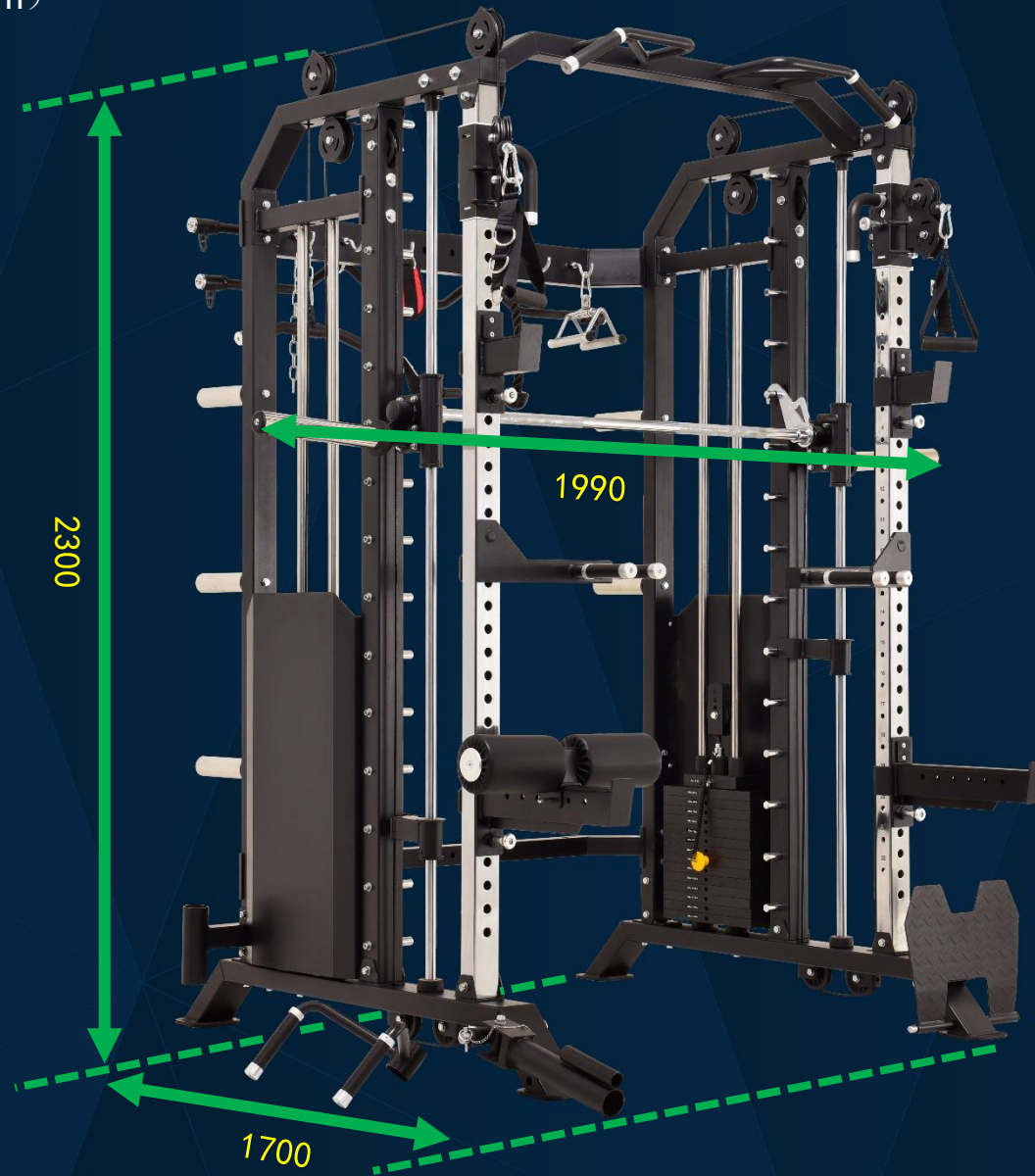

# G7A+G7W

COMMERCIAL SMITH MACHINE, POWER RACK AND FUNCTIONAL TRAINER 3 IN 1



Maximum weight & Main tube size



Maximum user weight: 350lbs

Maximum weight capacity (including user weight): 800lbs

□ 50 × 70 × 2

□ 50 × 2

□ 50 × 70 × 2.5

Φ 25 × 1.5

□ 70 × 2

Φ 25

□ 50 × 100 × 3

Φ 60 × 3.5

□ 50 × 70 × 3

□ 50 × 100 × 2

Φ 30

□ 50 × 70 × 3

□ 50 × 70 × 2

400 × 250 × 70 × 5

Φ 5

# G7A+G7W

COMMERCIAL SMITH MACHINE, POWER RACK AND FUNCTIONAL TRAINER 3 IN 1



## Characteristic

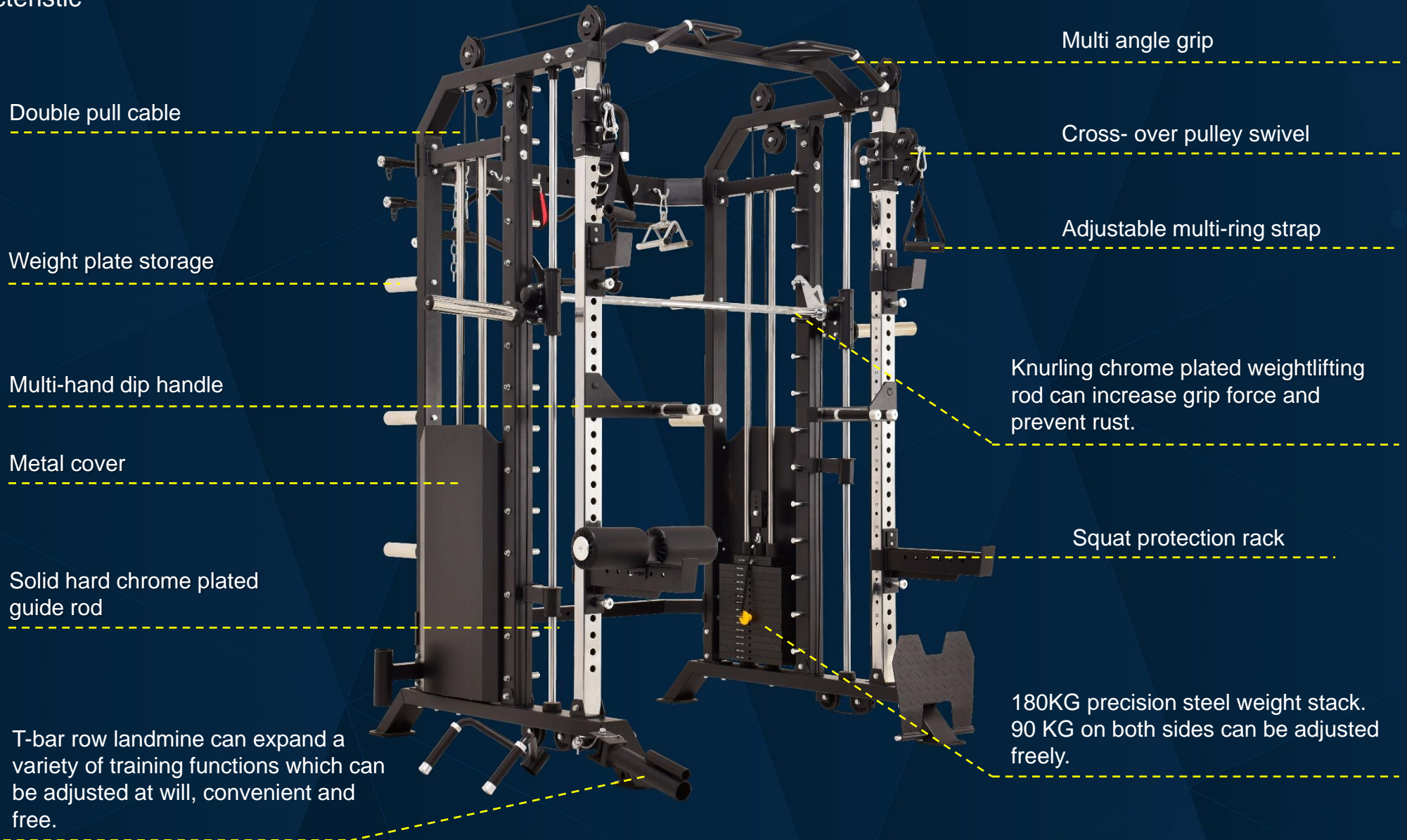



# G7A+G7W

COMMERCIAL SMITH MACHINE, POWER RACK AND FUNCTIONAL TRAINER 3 IN 1



Chin up

Multi angle Chin up bar

ordinary grip, underhand grip,  
mixed grip, sternum pull-up,  
one-hand pull-up,  
one-arm pull-up



Comfortable HDR handle grip

Aluminium alloy end cap

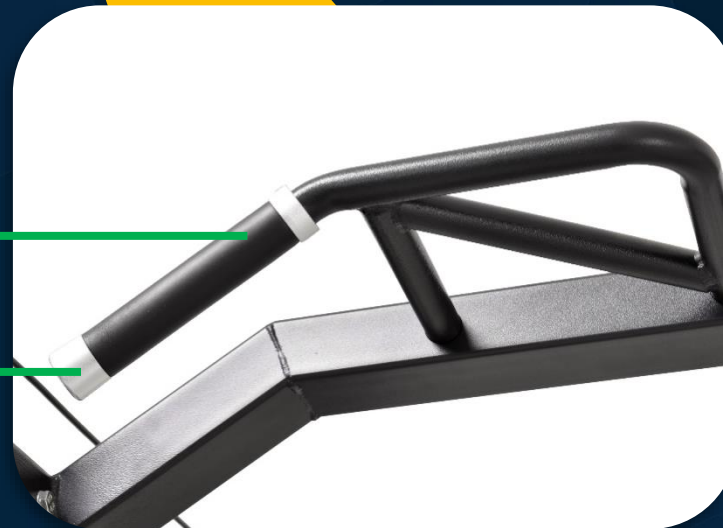

# G7A+G7W

COMMERCIAL SMITH MACHINE, POWER RACK AND FUNCTIONAL TRAINER 3 IN 1



Pulley

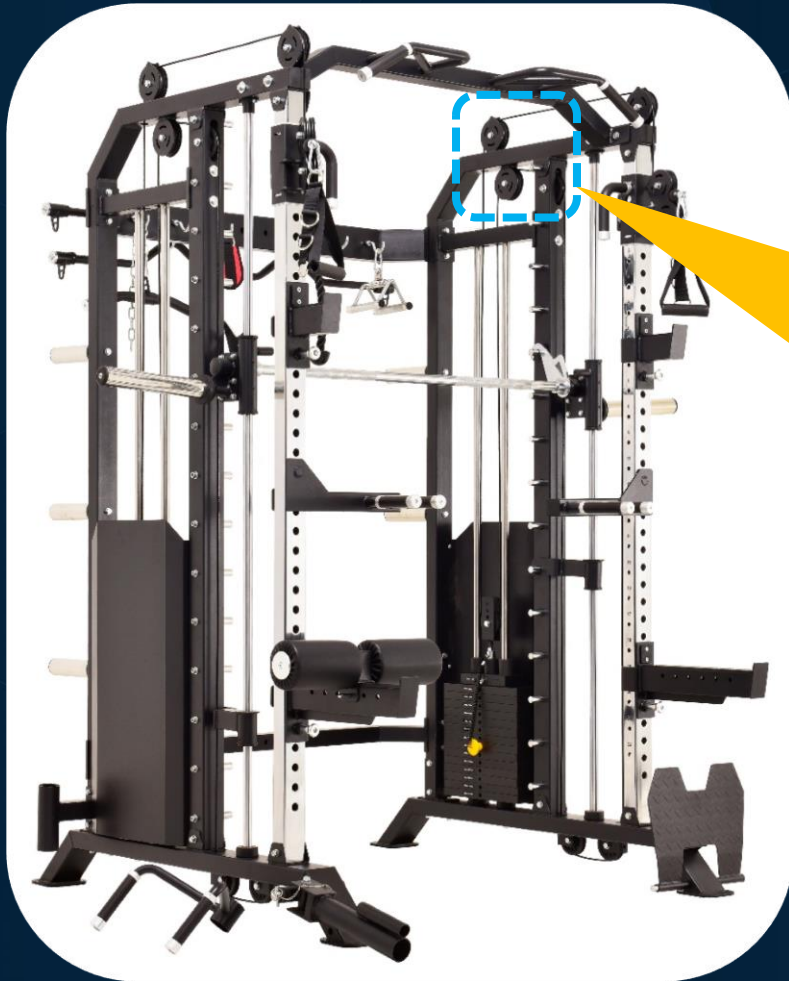

Multiple sets of converted pulleys make the movement smoother and save weight.



Φ5mm Cable has passed through 800 kg tension test. The cable is tensile, wear-resisting and safe.

# G7A+G7W

COMMERCIAL SMITH MACHINE, POWER RACK AND FUNCTIONAL TRAINER 3 IN 1



Details



Extended design ring clip buckle is strong match and impact resistance.



Humanized 10-segment height design is suitable for different height users to do squat bench press.



# G7A+G7W

COMMERCIAL SMITH MACHINE, POWER RACK AND FUNCTIONAL TRAINER 3 IN 1



Long safety rack



ABS pad, antiwear and deformation resistance



Steel safety rack has the protective function.

# G7A+G7W

COMMERCIAL SMITH MACHINE, POWER RACK AND FUNCTIONAL TRAINER 3 IN 1



Non-slip metal footplate



Humanized non-slip metal footplate with 5mm thickness can increase the force of friction with the sole.



It's more stable with increasing the contact area between the end and the ground.

# G7A+G7W

COMMERCIAL SMITH MACHINE, POWER RACK AND FUNCTIONAL TRAINER 3 IN 1



## Accessories storage

Complete more movements with different accessories to satisfy the whole body muscles

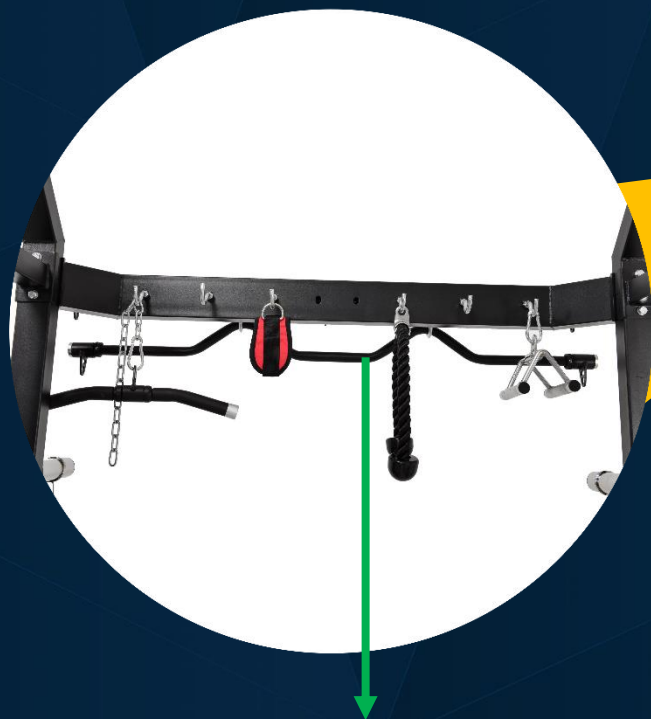

"W" type curved bar, curved bar can better fit the contour between the chest, reduce the risk of wrist injury, while increasing the angle change, is conducive to sculpture muscle details.





# G7A+G7W

COMMERCIAL SMITH MACHINE, POWER RACK AND FUNCTIONAL TRAINER 3 IN 1



Solid Olympic weightlifting rod

The whole welding is more stable.



Anti-skid thread design of solid Olympic weightlifting rod with chrome-plated knurling handle can increase force and more safety.



# G7A+G7W

COMMERCIAL SMITH MACHINE, POWER RACK AND FUNCTIONAL TRAINER 3 IN 1



## Smith structure

Hard chrome plated high precision Smith track can make the movement more smooth and prolong the service life of the machine.



Chrome plated sleeve, wear-resistant and rust-proof. It can match both 1" & 2" size weight plates. The max weight capacity is 277.5lbs.

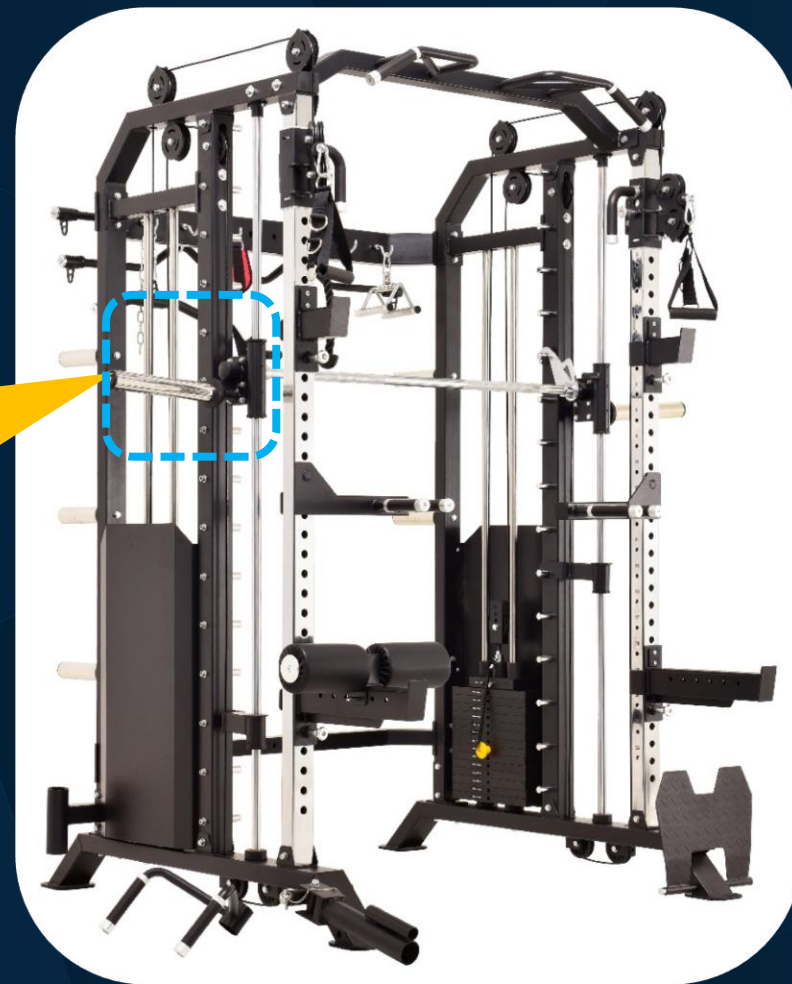

# G7A+G7W

COMMERCIAL SMITH MACHINE, POWER RACK AND FUNCTIONAL TRAINER 3 IN 1



Leather FOAM

High quality leather foam is anti-sweat and wear resisting.



Aluminum alloy FOAM block





# G7A+G7W

COMMERCIAL SMITH MACHINE, POWER RACK AND FUNCTIONAL TRAINER 3 IN 1



## Cross-over pulley swivel

The tension output can rotate 180 degrees freely to meet different training angles and ensure your training effect.

You can see the digital through the hole, Adjustable height.



Zinc plated knob set is easy to be adjusted.

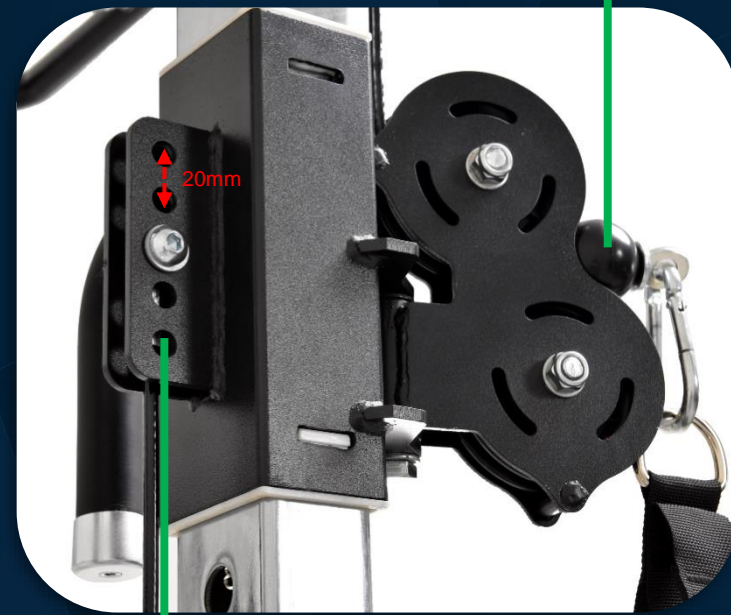

Cable length can be adjusted slightly.

# G7A+G7W

COMMERCIAL SMITH MACHINE, POWER RACK AND FUNCTIONAL TRAINER 3 IN 1



Weight stack

Metal cover not only can protect the case but also increase the stability of the machine.



Barbell storage bar can store 2.5-20KG six groups of weight plates. It's easy to use and flexible.

Olympic bar storage

Iron weight stack :6Kg × 15=90KG

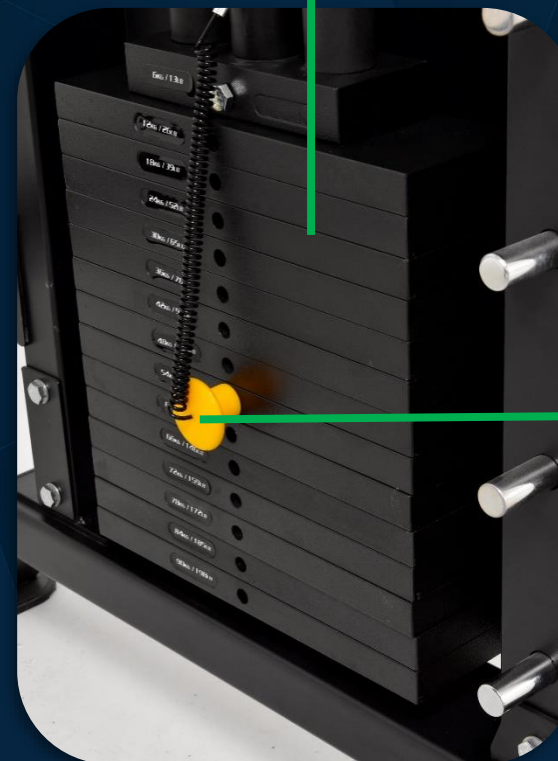

Magnetic pin avoids sliding during exercise.

US & European design idea  
Innovative technical patent



**IMBEL<sup>®</sup>**

**THE LEADER OF PROFESSIONAL STRENGTH FITNESS EQUIPMENTS**



Qingdao Imbell Sporting Goods Co., Ltd.

ADD: NO. 200 Shuangyuan Road, Jihongtan  
Subdistrict, Chengyang Qingdao, China

Export Tel: +86-532-89087512

E-mail: [katiez@imbell-fitness.com](mailto:katiez@imbell-fitness.com)

Website: [www.imbell-fitness.com](http://www.imbell-fitness.com)